



US010069974B1

(12) **United States Patent**
Ho et al.

(10) **Patent No.:** **US 10,069,974 B1**
(45) **Date of Patent:** ***Sep. 4, 2018**

(54) **CALL INITIATED SERVICE SESSION**

(71) Applicant: **TP Lab, Inc.**, Palo Alto, CA (US)

(72) Inventors: **Chi Fai Ho**, Palo Alto, CA (US); **Shin Cheung Simon Chiu**, Palo Alto, CA (US)

(73) Assignee: **TP Lab, Inc.**, Palo Alto, CA (US)

(*) Notice: Subject to any disclaimer, the term of this patent is extended or adjusted under 35 U.S.C. 154(b) by 0 days.

This patent is subject to a terminal disclaimer.

(21) Appl. No.: **15/485,306**

(22) Filed: **Apr. 12, 2017**

Related U.S. Application Data

(63) Continuation of application No. 14/050,355, filed on Oct. 10, 2013, now Pat. No. 9,654,635, which is a continuation of application No. 11/302,569, filed on Dec. 13, 2005, now Pat. No. 8,594,300.

(51) **Int. Cl.**
H04M 3/06 (2006.01)
H04M 3/51 (2006.01)

(52) **U.S. Cl.**
CPC .. **H04M 3/5191** (2013.01); **H04M 2203/1058** (2013.01)

(58) **Field of Classification Search**
CPC H04M 3/5191; H04M 2203/1058; H04L 67/14; H04L 29/06319
USPC 379/221.01, 265.09, 265.01; 370/352
See application file for complete search history.

(56) **References Cited**

U.S. PATENT DOCUMENTS

5,764,736	A *	6/1998	Shachar	H04L 29/06
				379/93.09
6,301,480	B1 *	10/2001	Kennedy, III	H04W 76/11
				455/445
7,082,191	B1 *	7/2006	Dickens	H04M 1/673
				379/128
2003/0110266	A1 *	6/2003	Rollins	H04L 29/06
				709/227
2005/0215228	A1 *	9/2005	Fostick	H04L 67/14
				455/403
2006/0059125	A1 *	3/2006	Yan	H04L 67/14
2006/0075110	A1 *	4/2006	Seraphin	H04L 63/08
				709/227

(Continued)

Primary Examiner — Ahmad F Matar

Assistant Examiner — Jirapon Intavong

(74) *Attorney, Agent, or Firm* — North Shore Patents, P.C.; Michele Liu Baillie

(57) **ABSTRACT**

A method and system for providing a service session using a call include: initiating a first call between a caller and a callee according to a callee address record; establishing a voice communication session during the call; modifying the caller address record; and initiating a second call between the caller and the callee according to the modified callee address record. A behavior of the second call differs from a behavior of the first call. In one embodiment, the callee address record is modified according to a modification request. In one embodiment, the callee address record includes at least one session initiation entry. The session initiation entry includes a session address attribute with information for establishing the communication session, a session communication method with a protocol used for the communication session, and a session data attribute with data information for sending over the communication session based on the session address attribute.

16 Claims, 11 Drawing Sheets

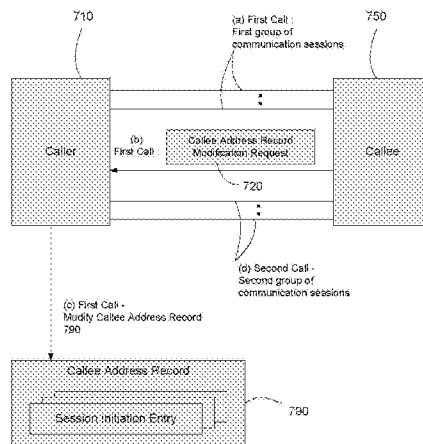

A Process of making two Calls wherein a second Call is based on a Caller Address Record modified during a first Call

(56)

References Cited

U.S. PATENT DOCUMENTS

2007/0037561 A1* 2/2007 Bowen H04M 1/274575
455/418

* cited by examiner

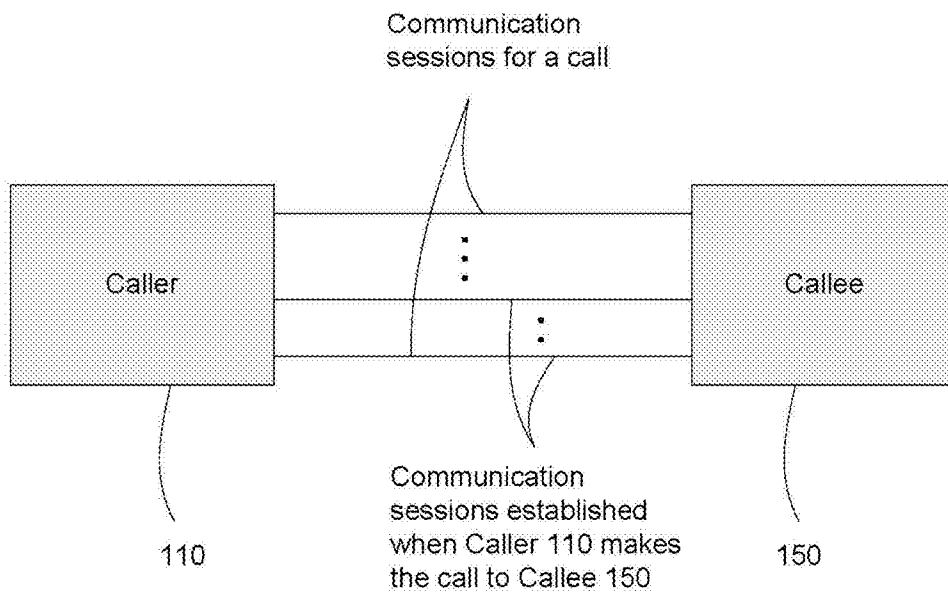

Figure 1. A Call between a Caller and a Callee

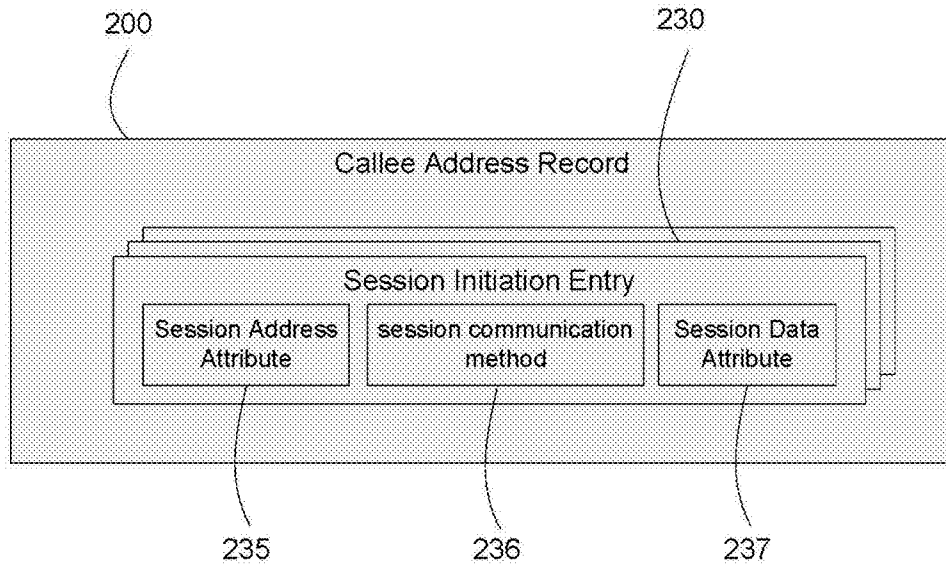

Figure 2. Callee Address Record

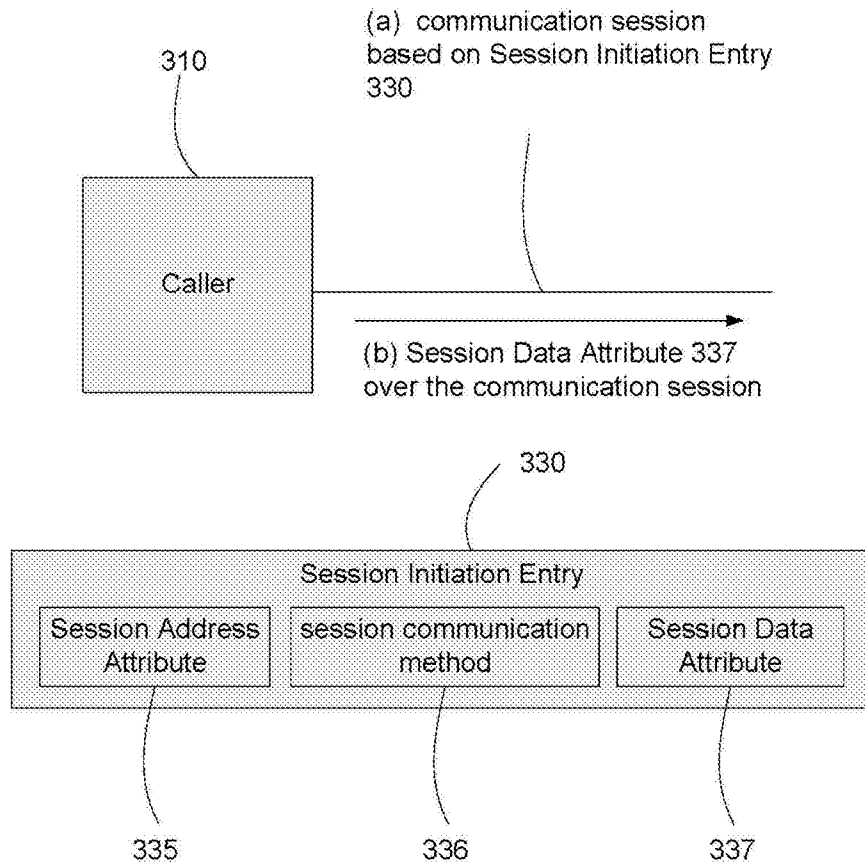

Figure 3. A Process of establishing a Communication Session

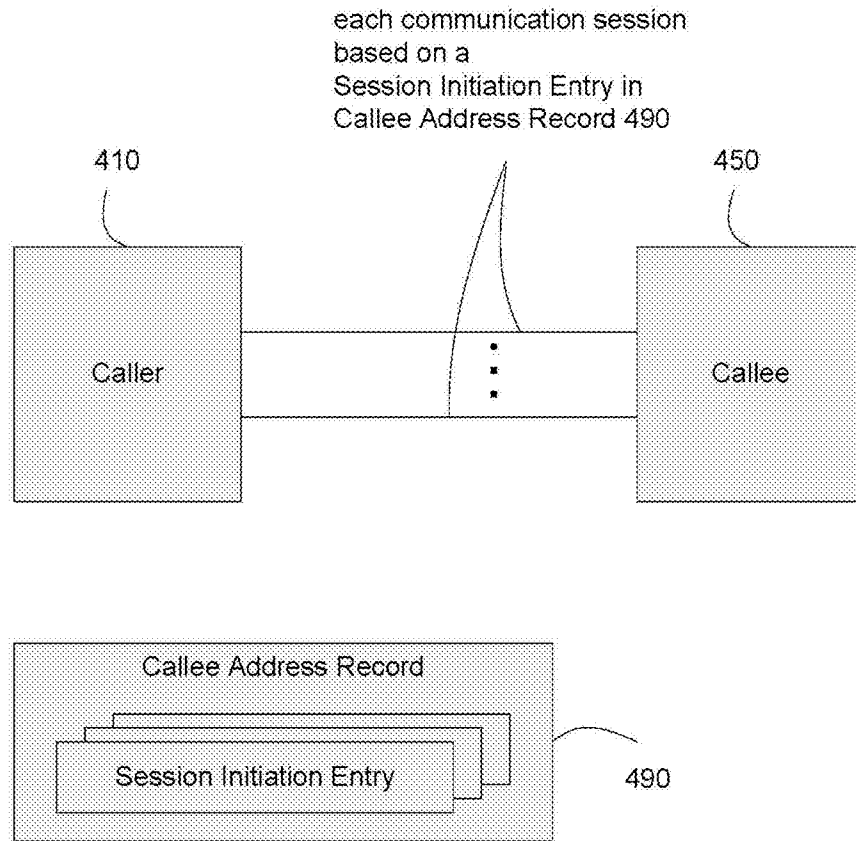

Figure 4. A Process of making a Call

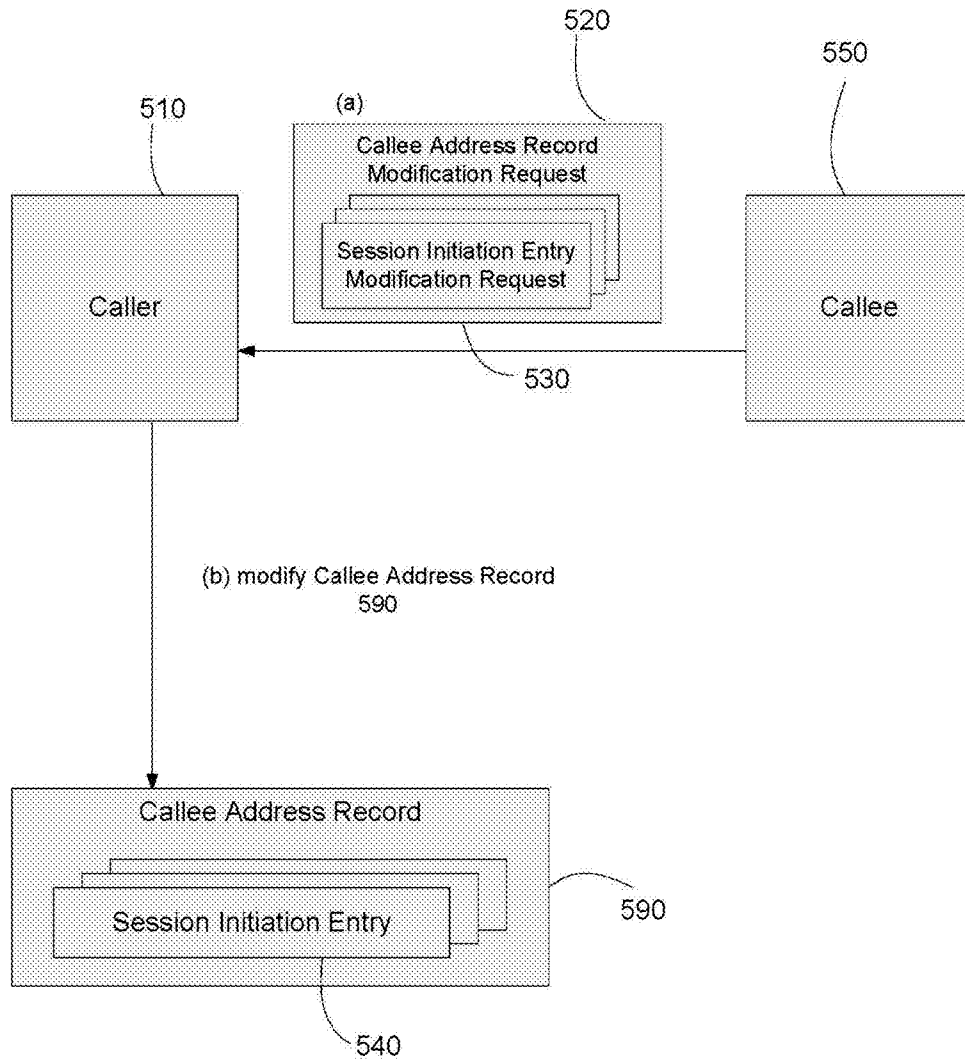

Figure 5. A Process of modifying a Callee Address Record during a Call

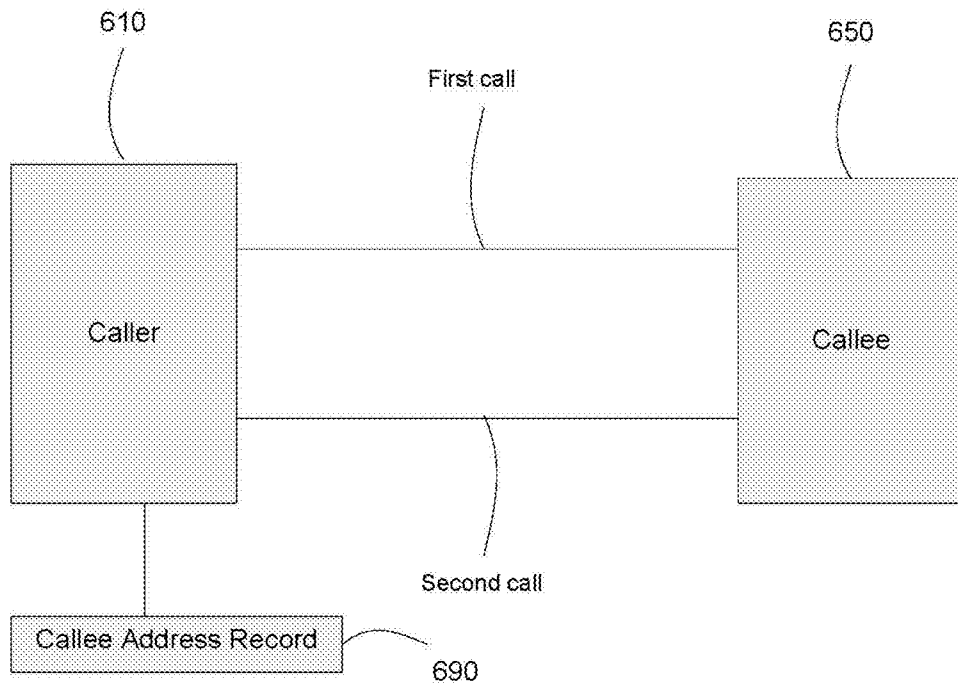

Figure 6. A Process of making two Calls wherein a second Call is within a time period after a first Call

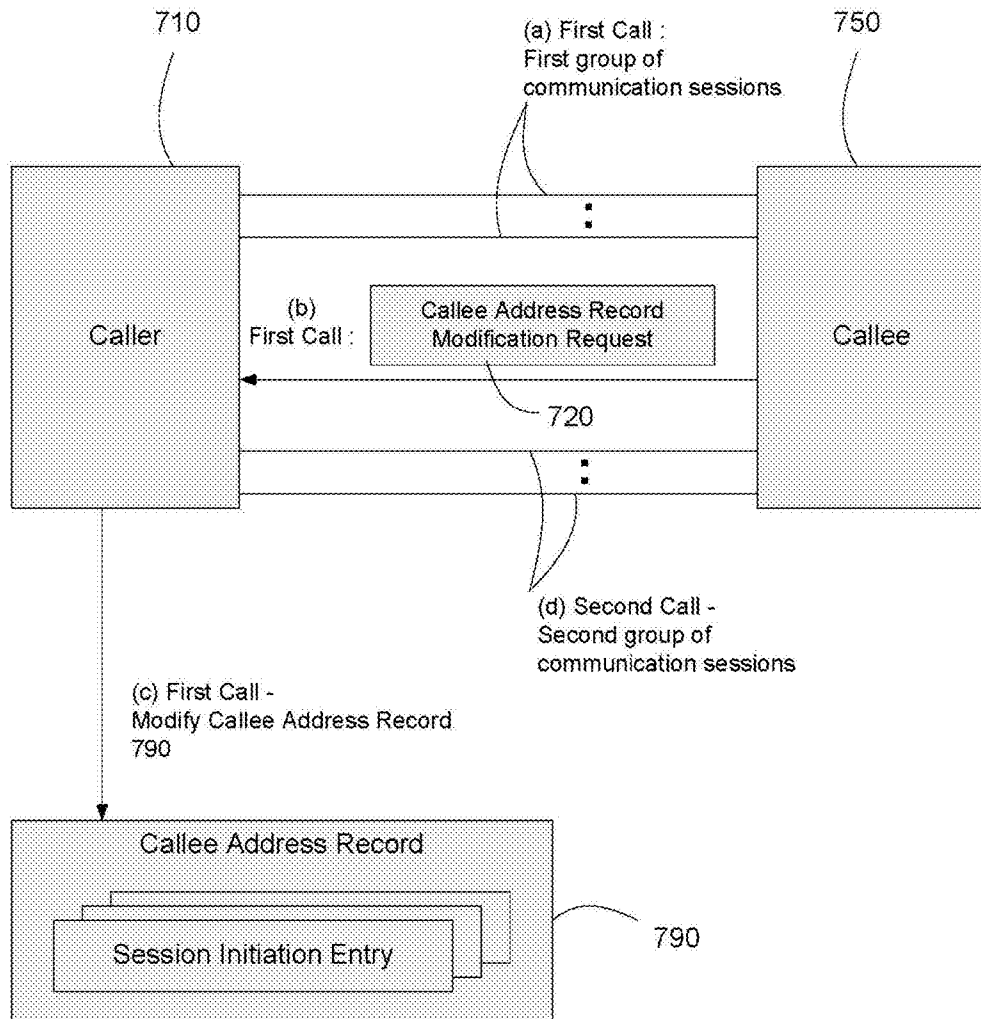

Figure 7. A Process of making two Calls wherein a second Call is based on a Caller Address Record modified during a first Call

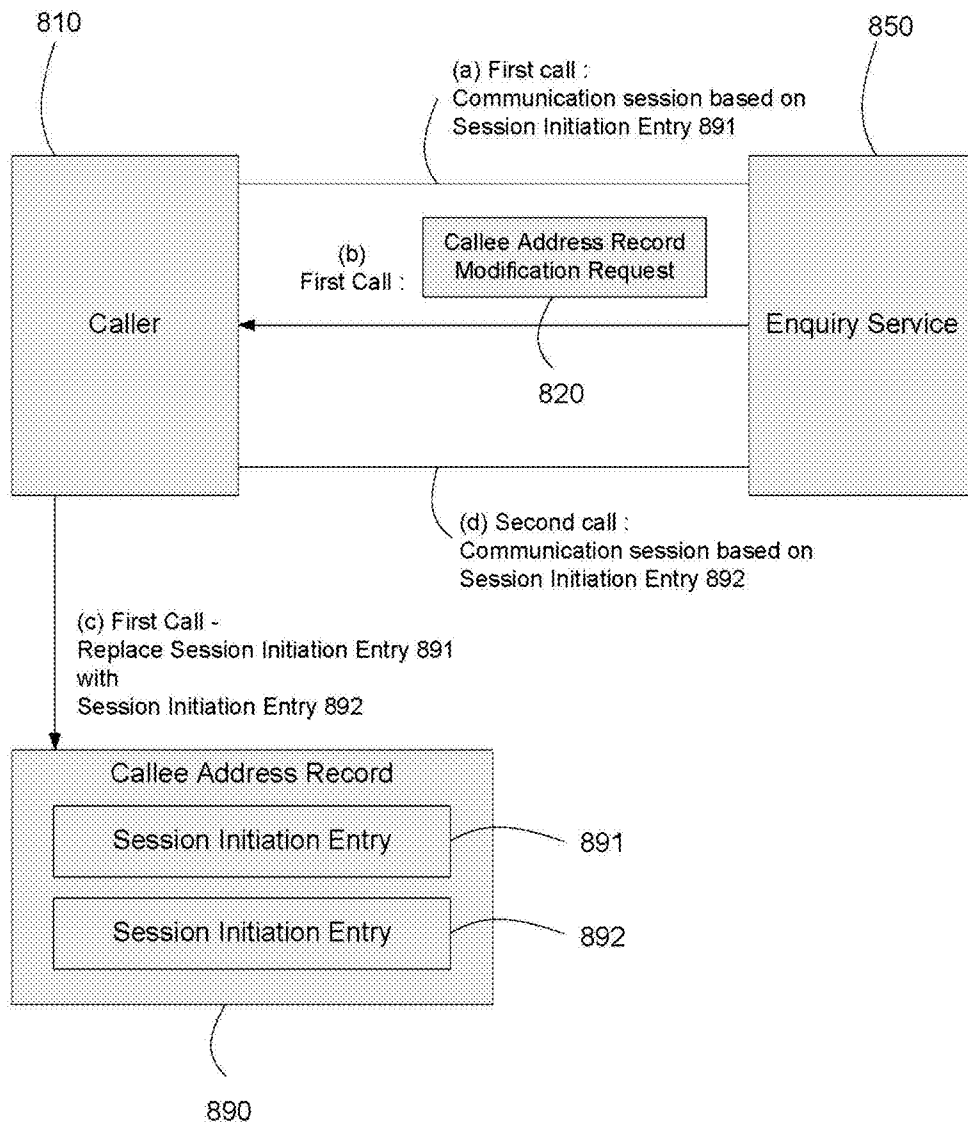

Figure 8. An Enquiry Service Process using a Call

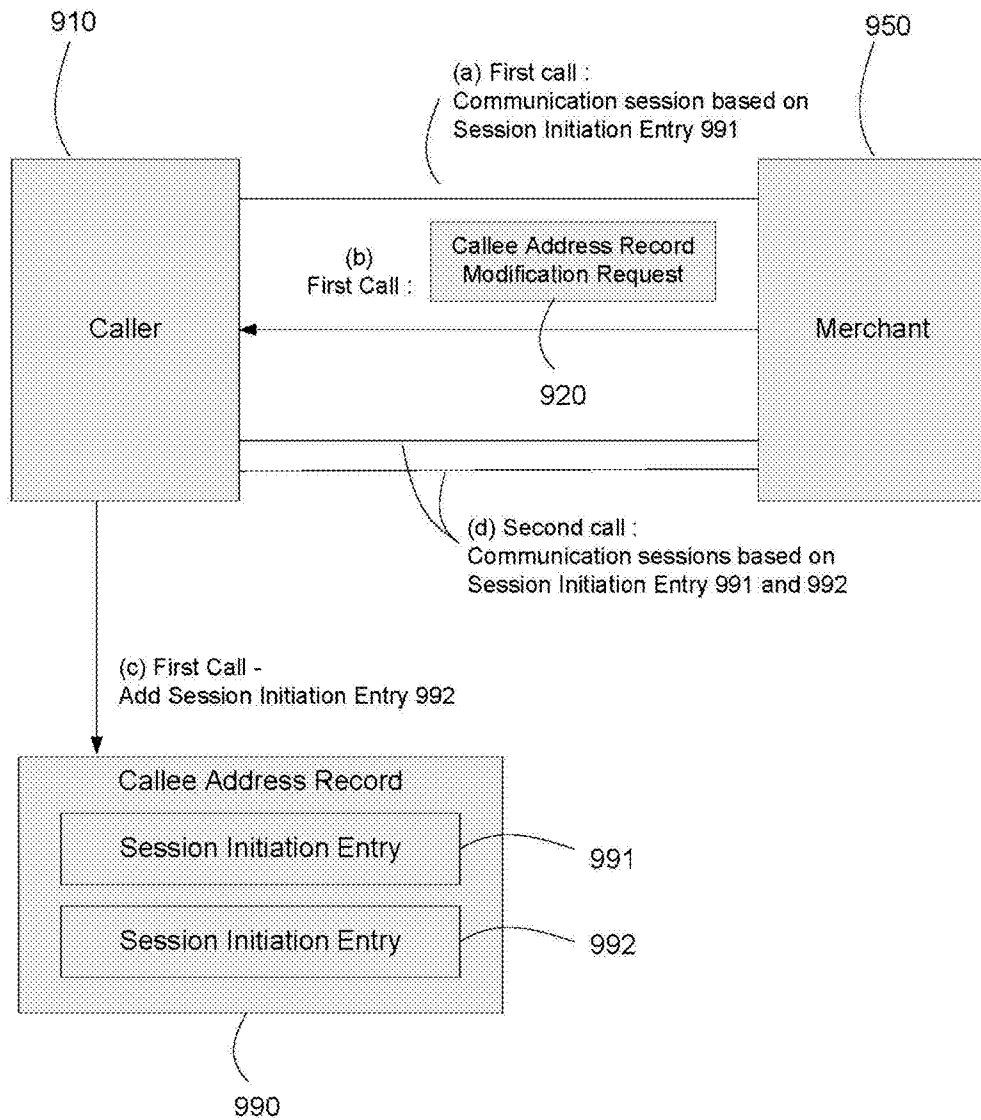

Figure 9. An Product Ordering Process using a Call

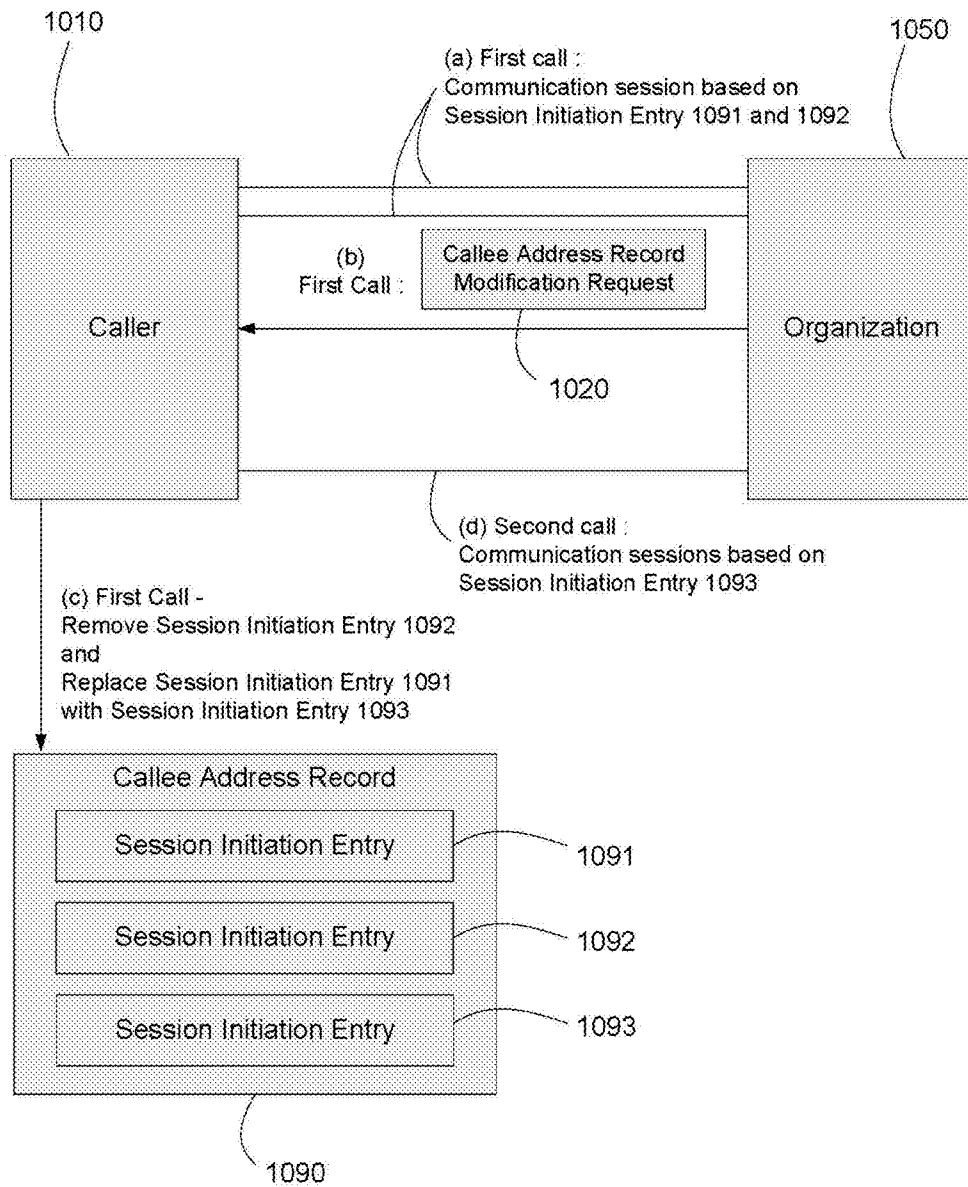

Figure 10. An Service Process based on a Callee assigned Identity using a Call

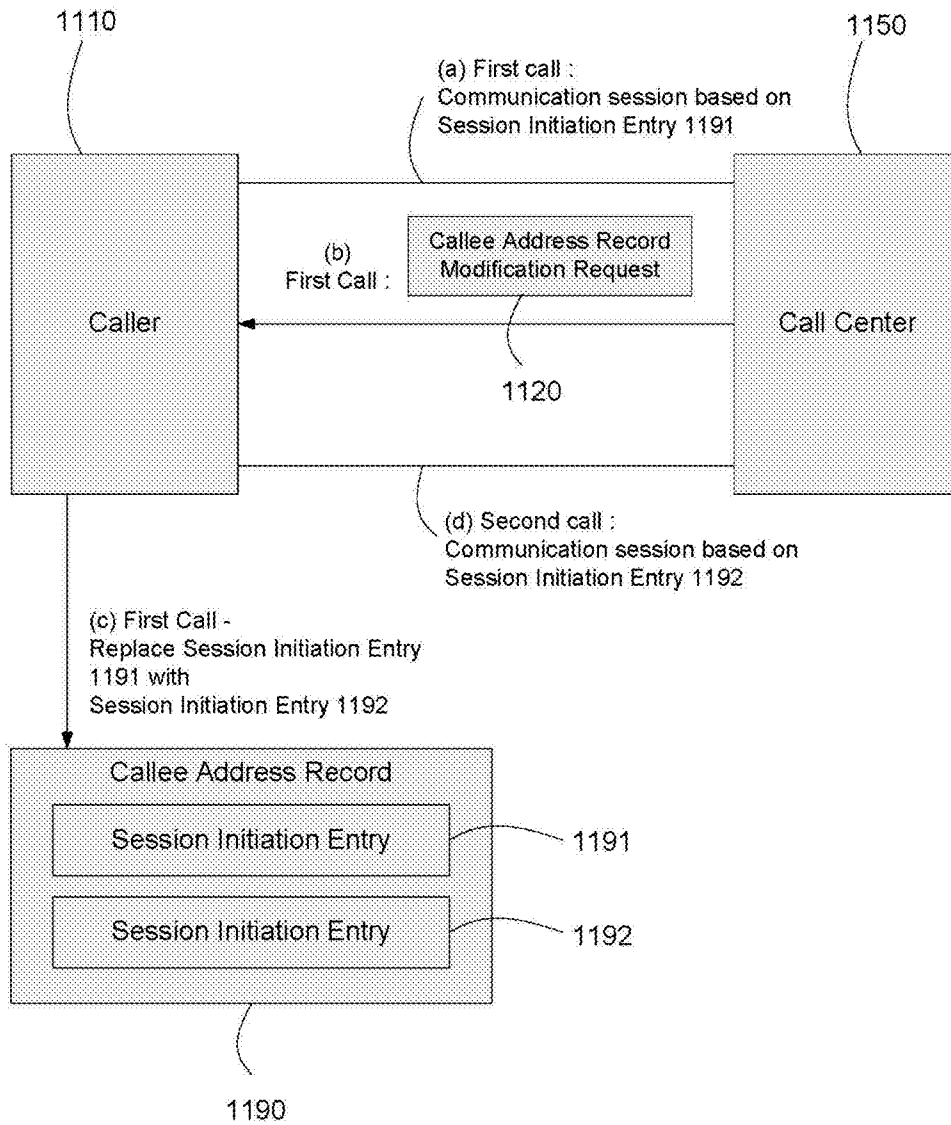

Figure 11. An Service Call-waiting Process using a Call

1

CALL INITIATED SERVICE SESSION

BACKGROUND OF THE INVENTION

Field

This invention relates generally to telecommunications, and more specifically, to a process to initiate a service session by making a call.

Related Art

Since the early 1970, new usages of voice communication have been introduced that allow a person to use a telephone to interact with a machine. Such usages are typically deployed for customer to business communication. In the simplest form, a person makes a telephone call to obtain information, such as location or business hours, from a recorded announcement machine of a merchant. Other more sophisticated usages include call center applications enabled by Interactive Voice Response (IVR) technologies. Such applications range from simple pin code authentication, merchandise ordering, ticket reservation, service scheduling, to complex class registration and financial transactions.

With the rapid commercialization of the Internet in the 1990s, a new form of customer to business communication emerges. A person can use a Web browser to obtain complex information from a business, and conduct sophisticated transactions, such as on-line shopping and on-line banking. This communication method has advantages over its voice counterpart, such as accurate data input, effective data presentation and navigation, no-loss data transmission, and mature security measures, such as on-demand data encryption and strong authentication methods.

Advanced data technologies, such as Customer Relationship Management (CRM) and client-side cookies, among others, further enhance customer to business interaction as communication and transactions history can be maintained beyond an autonomous communication session.

While providing convenience for customers, businesses manage and offer these methods of communication separately.

In one scenario, when a customer wishes to communicate with a business, he will have to decide whether to make a telephone call to the business' call center, or to connect to the business' Web site. In another scenario, while surfing the business' Web site, a customer may want to talk to a service representative of the business. In yet another scenario, while engaged in a telephone call with a service representative of a business, a customer may have a need to get information from the business' Web site. In one other scenario, a customer has made a reservation with a vacation resort over a telephone call, but will have to remember the Web site and a reservation number when she wants to find out updated details about the reservation.

The above scenarios illustrate the need to integrate voice and data communication between customers and businesses such that a customer can make a call to reach a business, automatically over voice communication, data communication, or both.

BRIEF SUMMARY OF THE INVENTION

A method and system for providing a service session using a call include: initiating a first call between a caller and a callee according to a callee address record; establishing a voice communication session during the call; modifying the

2

callee address record; and initiating a second call between the caller and the callee according to the modified callee address record. A behavior of the second call differs from a behavior of the first call. In one embodiment, the callee address record is modified according to a modification request. In one embodiment, the callee address record includes at least one session initiation entry. The session initiation entry includes a session address attribute with information for establishing the communication session, a session communication method with a protocol used for the communication session, and a session data attribute with data information for sending over the communication session based on the session address attribute.

BRIEF DESCRIPTION OF THE SEVERAL VIEWS OF THE FIGURES

FIG. 1 illustrates a call between a Caller and a Callee.

FIG. 2 illustrates a Callee Address Record.

FIG. 3 illustrates a process of establishing a communication session based on a Session Initiation Entry.

FIG. 4 illustrates a process of making a call.

FIG. 5 illustrates a process of modifying a Callee Address Record during a call.

FIG. 6 illustrates a process of making two calls wherein a second call is within a time period from a first call.

FIG. 7 illustrates a process of making two calls wherein a second call uses a Callee Address Record that is modified during a first call.

FIG. 8 illustrates an enquiry service process using a call.

FIG. 9 illustrates a product ordering process using a call.

FIG. 10 illustrates a service process based on a Callee assigned identity during a call.

FIG. 11 illustrates a service call-waiting process.

DETAILED DESCRIPTION OF THE INVENTION

A Call, a Caller, a Callee and Communication Sessions

FIG. 1 illustrates a call between a Caller and a Callee.

A call includes a plurality of communication sessions between Caller **110** and Callee **150**. Caller **110** and Callee **150** include functionalities of processing a communication session. In one embodiment, processing a communication session includes establishing, maintaining and terminating a communication session.

In one embodiment, the plurality of communication sessions includes one or more communication sessions Caller **110** establishes with Callee **150** when Caller **110** makes the call to Callee **150**.

In one embodiment, the plurality of communication sessions includes one or more communication sessions Caller **110** establishes with Callee **150** during the call.

During the call, Caller **110** and Callee **150** exchange information over the plurality of communication sessions.

A Callee Address Record

FIG. 2 illustrates a Callee Address Record. A Callee Address Record is for a Callee **150**.

Callee Address Record **200** includes a plurality of Session Initiation Entries **230**. Each Session Initiation Entry **230** includes information for a communication session to the Callee. A Session Initiation Entry **230** includes a Session Address Attribute **235**, a Session Data Attribute **237** and a session communication method **236**.

Session Address Attribute **235** includes address information for establishing a communication session. In one embodiment, Session Address Attribute **235** includes a tele-

phone number or a plurality of digits such as “4082130698”. In another embodiment, Session Address Attribute **235** includes a Universal Resource Indicator (URI) as specified in IETF RFC 2396, such as “http://reservation.easydiner.com” and “ftp://megastore/info/shippingpolicy.txt”. In yet another embodiment, Session Address Attribute **235** includes an Internet Protocol (IP) address such as “24.120.55.214”. In one other embodiment, Session Address Attribute **235** includes an IP address and an IP port number such as “33.132.23.156:80”. In one other embodiment, Session Address Attribute **235** includes a domain name as specified in IETF RFC 1034 and IETF RFC 1035, such as “info.ivysystem.net”.

In one embodiment, Session Data Attribute **237** includes data information for sending over the communication session based on Session Address Attribute **235**. In one embodiment, Session Data Attribute **237** includes a plurality of digits, such as “8096023”, or “3365989853”. In another embodiment, Session Data Attribute **237** includes a plurality of alphanumeric characters, such as “user=AE3092D; session=39485JD409” or “ID=JOHN-SMITH; ZIP-CODE=94023”. In yet another embodiment, Session Data Attribute **237** includes an octet string, such as “AD357F6CCD34E6AB8724” as expressed in hexadecimal format.

Session communication method **236** includes a protocol used for a communication session. In one embodiment, session communication method **236** is determined based on Session Address Attribute **235**. In one embodiment, Session Address Attribute **235** includes a URI such as “http://reservation.easydiner.com”. Session communication method **236** includes the HTTP protocol. In one embodiment, Session Initiation Entry **230** includes a separate session communication method attribute **236**. For example, Session Address Attribute **235** includes a telephone number; Session Initiation Entry **230** includes a session communication method attribute that includes a session communication method, such as “POTS”, “SIP”, “fax”, “modem” or “Fax over IP”.

In one embodiment, a Session Initiation Entry **230** includes an effective time information. In one embodiment, the effective time information includes a time of day; the Session Initiation Entry **230** becomes ineffective when the current time of day is after the effective time information. Caller does not establish a communication session based on an ineffective Session Initiation Entry.

In one embodiment, the effective time information includes a time period; the Session Initiation Entry **230** is ineffective when the current time of day is outside the effective time information.

In one embodiment, a Datastore stores a plurality of Callee Address Records **200**. In one embodiment, Caller includes the Datastore. In another embodiment, Caller connects to the Datastore. In one embodiment, Caller connects to the Datastore via a network, such as an Ethernet network, a home WiFi network, an Internet Protocol (IP) network, or the Internet. In another embodiment, Caller connects to the Datastore via a plurality of networks.

In one embodiment, the Datastore includes a flash memory. In another embodiment, the Datastore includes a hard disk. In yet another embodiment, the Datastore includes a memory. In one other embodiment, the Datastore includes a database.

A Process of Establishing a Communication Session

FIG. 3 illustrates a process of establishing a communication session based on a Session Initiation Entry.

Caller **310** establishes a communication session based on a Session Initiation Entry **330** (step (a)). Session Initiation Entry **330** includes Session Address Attribute **335**, a session communication method **336** and Session Data Attribute **337**.

In one embodiment, Caller **310** establishes a communication session based on Session Address Attribute **335** and session communication method **336**. In one embodiment, Session Address Attribute **335** includes a URI “http://reservation.easydiner.com”. In one embodiment, Caller **310** establishes a communication session using session communication method **336** “http” and the URI “http://reservation.easydiner.com”.

In one embodiment, Session Address Attribute **335** includes a telephone number “450-111-2222” and session communication method **336** “POTS”. Caller **310** establishes a communication session using session communication method **336** “POTS” and the telephone number “450-111-2222”.

In one embodiment, Caller **310** sends the data information in Session Data Attribute **337** over the communication session (step (b)).

In one embodiment, Caller **310** sends the data information in Session Data Attribute **337** during the set up time of the communication session. In one embodiment, the communication session is an HTTP communication session. In one example, Caller **310** includes the data information in Session Data Attribute **337** in a cookie header of an HTTP Request. Caller **310** sends the HTTP Request to establish the HTTP communication session. In another embodiment, the communication session is a Real Time Streaming Protocol (RTSP) communication session. In one example, Caller **310** includes the data information in Session Data Attribute **337** in a proprietary header of an RTSP SETUP Message. Caller **310** sends the RTSP SETUP Message to establish the RTSP communication session.

In another embodiment, Caller **310** sends the data information in Session Data Attribute **337** after the communication session is established. In one example, the communication session is based on session communication method “POTS”. In one embodiment, Caller **310** sends the data information in Session Data Attribute **337** in the form of Dual Tone Multiple Frequency (DTMF) tones after the communication session is established. In another example, the communication session is based on session communication method “SIP”. In one embodiment, Caller **310** sends the data information in Session Data Attribute **337** in a SIP INFO Message after the communication session is established.

A Process of Making a Call

FIG. 4 illustrates a process of making a call.

Caller **410** makes a call to Callee **450** using Callee Address Record **490**. Callee Address Record **490** is for Callee **450**. Caller **410** establishes a plurality of communication sessions to Callee **450** based on the plurality of Session Initiation Entry in Callee Address Record **490**.

For each Session Initiation Entry in Callee Address Record **490**, Caller **410** establishes a communication session to Callee **450** as illustrated in FIG. 3.

A Process of Modifying a Callee Address Record During a Call

FIG. 5 illustrates a process of modifying a Callee Address Record during a call.

Caller **510** makes a call to Callee **550** using Callee Address Record **590**. Caller **510** establishes a plurality of communication sessions to Callee **550** based on Callee Address Record **590**.

5

During the call, Caller **510** receives from Callee **550** a Callee Address Record Modification Request **520** (step (a)). A Callee Address Record Modification Request **520** is a request for the modification of a Callee Address Record. In one embodiment, the Callee Address Record Modification Request **520** is for the modification of Callee Address Record **590**. In one embodiment, the request **520** includes a plurality of Session Initiation Entry Modification Request **530**. A Session Initiation Entry Modification Request **520** is a request for the modification of a Session Initiation Entry. For each Session Initiation Entry Modification Request **530** in the Callee Address Record Modification Request **520**, Caller **510** modifies the respective Session Initiation Entry **540** in Callee Address Record **590** (step (b)).

In one embodiment, a Session Initiation Entry Modification Request **530** includes two Session Initiation Entry Indications (not shown). In one embodiment, a Session Initiation Entry Indication includes a Session Initiation Entry. In another embodiment, a Session Initiation Entry Indication does not include a Session Initiation Entry.

In one embodiment, the Session Initiation Entry Modification Request **530** is for the removal of a Session Initiation Entry. In one embodiment, the first Session Initiation Entry Indication includes a Session Initiation Entry and the second Session Initiation Entry Indication does not include a Session Initiation Entry. Caller **510** removes from Callee Address Record **590** a Session Initiation Entry **540** that matches the Session Initiation Entry in the first Session Initiation Entry Indication.

In another embodiment, the Session Initiation Entry Modification Request **530** is for the addition of a Session Initiation Entry. In one embodiment, the first Session Initiation Entry Indication does not include a Session Initiation Entry and the second Session Initiation Entry Indication includes a Session Initiation Entry. Caller **510** adds to Callee Address Record **590** the Session Initiation Entry **540** in the second Session Initiation Entry Indication.

In one other embodiment, the Session Initiation Entry Modification Request **530** is for the replacement of a Session Initiation Entry. In one embodiment, the first Session Initiation Entry Indication includes a first Session Initiation Entry and the second Session Initiation Entry Indication includes a second Session Initiation Entry. Caller **510** replaces in Callee Address Record **590** a Session Initiation Entry **540** that matches the first Session Initiation Entry with the second Session Initiation Entry.

A Process of Making Two Calls Wherein a Second Call is within a Time Period from a First Call

FIG. **6** illustrates a process of making two calls wherein a second call is within a time period from a first call.

Caller **610** makes a first call to Callee **650** using Callee Address Record **690**.

During the first call, in one embodiment, Caller **610** receives a time period information from Callee **650**. In one embodiment, Caller **610** further receives an indication to call within the time period from the first call. The callee **650** stores information for Caller's second call. In one embodiment, the time period is 30 minutes. In another embodiment, the time period is 55 minutes. In yet another embodiment, the time period is 2 day 8 hours.

During the first call, in another embodiment, Caller **610** sends a time period information to Callee **650**. In one embodiment, Caller **610** further sends an indication to call within the time period from the first call. In one embodiment, the time period is 25 minutes. In another embodiment, the time period is 46 minutes. In yet another embodiment, the time period is 1 day 6 hours.

6

Within the time period from the first call, Caller **610** makes a second call to Callee **650** using Callee Address Record **690**. The behavior of the second call is different from the first call according to the information for the second call, stored at the Callee **650**.

A Process of Making Two Calls Wherein a Second Call is Based on a Callee Address Record that is Modified During a First Call

FIG. **7** illustrates a process of making two calls wherein a second call uses a Callee Address Record that is modified during a first call.

Caller **710** makes a first call to Callee **750** using Callee Address Record **790** (step (a)). Caller **710** processes a first group of communication sessions with Callee **750**. The first group of communication sessions includes the plurality of communication sessions based on Callee Address Record **790**. During the first call, Caller **710** and Callee **750** exchange information over the first group of communication sessions.

Caller **710** receives from Callee **750** a Callee Address Record Modification Request **720** for Callee Address Record **790** (step (b)). Caller **710** modifies Callee Address Record **790** based on the Callee Address Record Modification Request as illustrated in FIG. **5** (step (c)).

Caller **710** makes a second call to Callee **750** using the modified Callee Address Record **790** (step (d)). Caller **710** processes a second group of communication sessions with Callee **750**. The second group of communication sessions includes the plurality of communication sessions based on the modified Callee Address Record **790**. During the second call, Caller **710** and Callee **750** exchange information over the second group of communication sessions.

In one embodiment, the second group of communication sessions is different from the first group of communication sessions.

In one embodiment, during the first call, the Callee Address Record Modification Request **720** is for the removal of a Session Initiation Entry. The first group of communication sessions includes a communication session based on the removed Session Initiation Entry, and the second group of communication sessions does not include a communication session based on the removed Session Initiation Entry.

In another embodiment, during the first call, the Callee Address Record Modification Request **720** is for the addition of a Session Initiation Entry. The first group of communication sessions does not include a communication session based on the added Session Initiation Entry, and the second group of communication sessions includes a communication session based on the added Sessions Initiation Entry.

In one other embodiment, during the first call, the Callee Address Record Modification Request **720** is for the replacement of a first Session Initiation Entry with a second Session Initiation Entry. In one embodiment, the first Session Address Attribute or the first session communication method in the first Session Initiation Entry is different from the second Session Address Attribute or the second session communication method in the second Session Initiation Entry. The first group of communication sessions includes the communication session based on the first Session Address Attribute and the first session communication method. The second group of communication sessions includes the communication session based on the second Session Address Attribute and the second session communication method. In another embodiment, the first Session Data Attribute in the first Session Initiation Entry is different from the second Session Data Attribute in the second Session Initiation Entry. Over the communication session

based on the first Session Initiation Entry, Caller **710** sends the first Session Data Attribute. Over the communication session based on the second Session Initiation Entry, Caller **710** sends the second Session Data Attribute.

An Enquiry Service Process Using a Call

FIG. **8** illustrates an enquiry service process using a call. An Enquiry Service provides information to a Caller. In this illustration, Enquiry Service **850** provides business contact information.

Caller **810** makes a first call to Enquiry Service **850** using Callee Address Record **890** for Enquiry Service **850** (step (a)). Callee Address Record **890** includes a Session Initiation Entry **891**. In one embodiment, Session Initiation Entry **891** includes Session Address Attribute with a telephone number “408-223-1234” and session communication method “SIP”. Caller **810** establishes a communication session to Enquiry Service **850** using the telephone number “408-223-1234” and the session communication method “SIP”.

Caller **810** receives a request from Enquiry Service **850** for caller information. Caller **810** sends the caller information to Enquiry Service **850**. In one embodiment, the caller information includes the name of a city “Mountain View, Calif.”. Caller **810** receives a request from Enquiry Service **850** for the name of a business. Caller **810** sends the name of a business, for example “Grasshopper Nursery” to Enquiry Service **850**. Caller **810** receives from Enquiry Service **850** a telephone number of Grasshopper Nursery at Mountain View, Calif.

Caller **810** receives from Enquiry Service **850** a Callee Address Record Modification Request **820** for the modification of Callee Address Record **890** (step (b)). In one embodiment, the Callee Address Record Modification Request **820** includes a Session Initiation Entry Modification Request for the replacement of Session Initiation Entry **891** with Session Initiation Entry **892**. Session Initiation Entry **892** includes Session Address Attribute with a telephone number “408-223-5678”, session communication method “SIP”, and Session Data Attribute “City=Mountain View/California”. In one embodiment, the Session Data Attribute corresponds to the caller information.

Caller **810** replaces Session Initiation Entry **891** with Session Initiation Entry **892** (step (c)).

Later, Caller **810** makes a second call to Enquiry Service **850** using the modified Callee Address Record **890** (step (d)). The modified Callee Address Record **890** includes Session Initiation Entry **892**. Caller **810** establishes a communication session to Enquiry Service **850** using the telephone number “408-223-5678” and the session communication method “SIP”. Over the communication session, Caller **810** sends the Session Data Attribute “City=Mountain View/California” to Enquiry Service **850**.

Caller **810** receives a request from Enquiry Service **850** for the name of a business. Caller **810** sends “Saturday Hardware”. Caller **810** receives from Enquiry Service **850** a telephone number of Saturday Hardware at Mountain View, Calif.

Similar to the illustration in FIG. **8**, Enquiry Service provides other information for a Caller.

In one embodiment, the Session Data Attribute in the replaced Session Data Attribute corresponds to the caller information.

In one embodiment, Enquiry Service **850** provides traffic condition information. In one embodiment, the caller information includes a location, such as a name of a highway. In the second call, Caller **810** receives from Enquiry Service **850** traffic condition information about the highway. In another embodiment, the caller information includes a start

address and a destination address. In the second call, Caller **810** receives from Enquiry Service **850** traffic condition information from the start address to the destination address.

In one embodiment, Enquiry Service **850** provides weather information. In one embodiment, the caller information includes a location, such as a name of a city, a town, a ski resort, or a beach. In the second call, Caller **810** receives from Enquiry Service **850** weather information about the location.

In one embodiment, Enquiry Service **850** provides event information. In one embodiment, the caller information includes a personal interest, such as a sport, a hobby, a name of a rock band or a name of a religion. In the second call, Caller **810** receives from Enquiry Service **850** event information, such as information about ball games, exhibitions, conferences, concert, or church services based on the personal interest.

In one embodiment, Enquiry Service **850** provides advertisement and promotion information. In one embodiment, the caller information includes a location, such as a name of a city, a shopping mall or a highway exit. In one embodiment, the other caller includes a personal interest for products or services, such as Chinese food, sports equipment, five-star hotels. In the second call, Caller **810** receives from Enquiry Service **850** advertisement and promotion information based on the location and the personal interest. In one embodiment, the location includes Stanford Shopping Center, and the personal interest includes baby’s clothing. In the second call, Caller **810** receives from Enquiry Service **850** advertisement information for Baby Blue Boutique at the northwest corner of Stanford Shopping Center. In another embodiment, the location includes a name of a highway exit and a direction of travel, and the personal interest includes pizza. In the second call, in one embodiment, Caller **810** receives from Enquiry Service **850** advertisement information for LazerFast Pizza located 10 miles from the highway exit in the direction of travel. In another embodiment, Caller **810** receives from Enquiry Service **850** advertisement information for Honest Pizza located 6 miles from the highway exit in the direction of travel.

A Product Ordering Process Using a Call

FIG. **9** illustrates a product ordering process using a call. In this illustration, Merchant **950** allows a Caller **910** to order products using a call.

Caller **910** makes a first call to Merchant **950** using Callee Address Record **990** (step (a)). Callee Address Record **990** includes a Session Initiation Entry **991**. In one embodiment, Session Initiation Entry **991** includes Session Address Attribute with a telephone number “650-354-6293” and session communication method “SIP”. Caller **910** establishes a communication session to Merchant **950** using the telephone number “650-354-6293” and the session communication method “SIP”.

Caller **910** provides to Merchant **950** order information. The order information includes the ordered products. In one embodiment, the order information includes a recipient name “Mary Logan”. In one other embodiment, the order information includes a street address for the delivery of the ordered products.

Caller **910** receives from Merchant **950** a Callee Address Record Modification Request **920** for the modification of Callee Address Record **990** (step (b)). In one embodiment, the Callee Address Record Modification Request **920** includes a Session Initiation Entry Modification Request for the addition of Session Initiation Entry **992**. In one embodiment, Session Initiation Entry **992** includes Session Address Attribute with a URI “http://ordertracking.laserfast-

pizza.com/order/” and Session Data Attribute with “ORDER_NUMBER=067498735”. In one embodiment, the Session Data Attribute corresponds to the order.

Caller **910** adds Session Initiation Entry **992** to Callee Address Record **990** (step (c)).

Later, Caller **910** makes a second call to Merchant **950** using Callee Address Record **990** (step (d)). The modified Callee Address Record **990** includes Session Initiation Entries **991** and **992**.

Caller **910** establishes a first communication session to Merchant **950** based on Session Initiation Entry **991** in a similar manner as in the first call.

Caller **910** establishes a second communication session to Merchant **950** based on Session Initiation Entry **992**. In one embodiment, Caller **910** composes an HTTP GET Request using the URI “http://ordertracking.laserfastpizza.com/order/”, and includes “ORDER_NUM=067498735” in a cookie header in the HTTP GET Request. Caller **910** sends the HTTP GET Request to Merchant **950**.

Caller **910** receives from Merchant **950** a Web page over the second communication session. In one embodiment, the Web page includes information about the order. In one embodiment, Caller **910** receives a greeting from Merchant **950** over the first communication session, “Dear Mary Logan, our deliveryman Joe Leach is on his way, and will arrive at approximately 12:35 pm. We at Laser Fast Pizza thank you for your business.”

In one embodiment, other business processes are variations of the Product Ordering Process.

In one embodiment, Caller **910** and Merchant **950** carries out a business process in the first call. The Session Data Attribute in the added Session Initiation Entry during the first call includes progress information about the business process. In one embodiment, the business process includes multiple steps. In one embodiment, Caller **910** and Merchant **950** complete the first and second steps of the process in the first call. In one embodiment, the Session Data Attribute include progress information “PROCESS-NUM=2361; STEP=2”.

In a second call, Caller **910** sends the progress information “PROCESS-NUM=2361; STEP=2” to Merchant **950**. Caller **910** and Merchant **950** resume the business process at the third step.

In one embodiment, Caller **910** and Merchant **950** continue the business process in additional calls in a similar manner. For example, Caller **910** and Merchant **950** complete the third, fourth, and fifth steps of the process in the second call. During the second call, in one embodiment, Caller **910** receives a Callee Address Record Modification Request for the replacement of a Session Initiation Entry. The Session Data Attribute in the replaced Session Initiation Entry includes progress information “PROCESS-NUM=2361; STEP=5”. In a third call, Caller and Callee resume the business process at the sixth step.

In one embodiment, Caller **910** corresponds to a customer and Merchant **950** corresponds to a business. Caller **910** and Merchant **950** carry out a customer-to-business process. In another embodiment, Caller **910** corresponds to a business and Merchant **950** corresponds to another business. Caller **910** and Merchant **950** carry out a business-to-business process. In one other embodiment, Caller **910** corresponds to an employee of a business and Merchant **950** corresponds to a service within the business. Caller **910** and Merchant **950** carry out an employee-to-service process.

A Service Process Based on a Callee Assigned Identity Using a Call

FIG. **10** illustrates a service process based on a Callee assigned identity during a call. In this illustration, Organization **1050** provides services to a Caller. The service process depends on if a Caller is a member of Organization **1050**. Organization **1050** provides non-member service to a Caller who is not a member of Organization **1050**, and provides membership service to a Caller who is a member of Organization **1050**.

In this illustration, a Caller **1010** is not a member of Organization **1050**.

Caller **1010** makes a first call to Organization **1050** using Callee Address Record **1090** (step (a)). Callee Address Record **1090** includes a Session Initiation Entry **1091** and a Session Initiation Entry **1092**. In one embodiment, Session Initiation Entry **1091** includes Session Address Attribute with a telephone number “510-200-3000” and session communication method “POTS”. Session Initiation Entry **1092** includes Session Address Attribute with a URI “http://www.ivygreengolfclub.org”. Caller **1010** establishes a first communication session to Organization **1050** using the telephone number “510-200-3000” and the session communication method “POTS”. Caller **1010** establishes a second communication session to Organization **1050** using the URI “http://www.ivygreengolfclub.org”.

Caller **1010** receives non-member service from Organization **1050** during the first call.

In one embodiment, during the first call, over the first communication session, Caller **1010** receives a recorded voice message from Organization **1050** introducing the benefits of joining Organization **1050**. Over the second communication session, Caller **1010** receives information about Organization **1050** from a Web page Organization **1050** sends. Caller **1010** becomes a member of Organization **1050**. Caller **1010** provides information to Organization **1050**. In one embodiment, the information includes a name “David Rice”. In another embodiment, the information includes personal preference.

Caller **1010** receives from Organization **1050** a Callee Address Record Modification Request **1020** for the modification of Callee Address Record **1090** (step (b)). In one embodiment, the Callee Address Record Modification Request **1020** includes a Session Initiation Entry Modification Request for the removal of Session Initiation Entry **1092**, and a Session Initiation Entry Modification Request for the replacement of Session Initiation Entry **1091** with Session Initiation Entry **1093**. In one embodiment, Session Initiation Entry **1093** includes Session Address Attribute with a telephone number “510-200-8888”, session communication method “POTS”, and Session Data Attribute with “MEMBER_NUM=1243600”. In one embodiment, the Session Data Attribute corresponds to membership information.

Caller **1010** removes Session Initiation Entry **1092** from Callee Address Record **1090** and replaces Session Initiation Entry **1091** with Session Initiation Entry **1093** (step (c)).

Later, Caller **1010** makes a second call to Organization **1050** using Callee Address Record **1090** (step (d)). The modified Callee Address Record **1090** includes Session Initiation Entry **1093**. Caller **1010** establishes a communication session to Organization **1050** using the telephone number “510-200-8888” and session communication method “POTS”. Caller **1010** sends “MEMBER_NUM=1243600” to Organization **1050** over the communication session.

Caller **1010** receives member service from Organization **1050** during the second call.

In one embodiment, Caller **1010** receives a greeting from a service representative of Organization **1050** over the

11

communication session, “Hi, Mr. Rice, welcome to Ivy Green Golf Club. We have a promotion for new member like you and I would be delighted to introduce to you these great services and discount that fits your personal preference”

In one embodiment, Organization **1050** provides services to a Caller **1010**. The service process depends on if a Caller **1010** is an existing customer. In one embodiment, the service process depends on a Callee assigned customer identity.

In one embodiment, Caller **1010** is not an existing customer when Caller **1010** makes the first call to Organization **1050**.

In one embodiment, the Session Data Attribute in the replaced Session Initiation Entry includes a Callee assigned customer identity. In one embodiment, the Session Data Attribute includes the Callee assigned customer identity “CUSTOMER-ID=9808765”.

In the second call, Caller **1010** receives service from Organization **1050** as an existing customer. In one embodiment, Caller **1010** receives specific service from Organization **1050** as the existing customer based on the Callee assigned customer identity “CUSTOMER-ID=9808765”.

A Service Call-Waiting Process Using a Call

FIG. **11** illustrates a service call-waiting process. A Caller calls a Call Center for a service.

Caller **1110** makes a first call to Call Center **1150** using Callee Address Record **1190** (step (a)). Callee Address Record **1190** includes a Session Initiation Entry **1191**. In one embodiment, Session Initiation Entry **1191** includes Session Address Attribute with a telephone number “800-828-1096” and session communication method “SIP”. Caller **1110** establishes a communication session using the telephone number “800-828-1096” and session communication method “SIP”.

Caller **1110** receives from Call Center **1150** a Callee Address Record Modification Request **1120** for the modification of Callee Address Record **1190** (step (b)). In one embodiment, the Callee Address Record Modification Request includes a Session Initiation Entry Modification Request **1120** for the replacement of Session Initiation Entry **1191** with Session Initiation Entry **1192**. In one embodiment, Session Initiation Entry **1192** includes Session Address Attribute with a telephone number “800-828-1096”, session communication method “SIP”, and Session Data Attribute “CALL_ARRIVAL_TIME=0930 pm:July:20:2005”. In one embodiment, the Session Data Attribute corresponds to the arrival time of the first call.

Caller **1110** replaces Session Initiation Entry **1191** with Session Initiation Entry **1192** (step (c)).

About fifty minutes later, Caller **1110** makes a second call to Call Center **1150** using Callee Address Record **1190** (step (d)). The modified Callee Address Record **1190** includes Session Initiation Entry **1192**. Caller **1110** establishes a communication session using the telephone number “800-828-1096” and session communication method “SIP”. Caller **1110** sends “CALL_ARRIVAL_TIME=0930 pm:July:20:2005” to Call Center **1150** over the communication session.

In one embodiment, Caller **1110** receives service from a customer service representative of Call Center **1150** immediately.

Foregoing described embodiments of the invention are provided as illustrations and descriptions. They are not intended to limit the invention to precise form described. In particular, it is contemplated that functional implementation of invention described herein may be implemented equiva-

12

lently in hardware, software, firmware, and/or other available functional components or building blocks, and that networks may be wired, wireless, or a combination of wired and wireless. Other variations and embodiments are possible in light of above teachings, and it is thus intended that the scope of invention not be limited by this Detailed Description, but rather by Claims following.

What is claimed is:

1. A method for conducting a product order transaction, comprising:

(a) establishing by a voice and data processing device, a first group of sessions with a merchant system using a first merchant record for a merchant, the first merchant record comprising a session data and a first session address for the merchant, the first group of sessions comprising a first voice session and a first data session;

(b) during the first voice session, processing, by the voice and data processing device, voice signals between a customer and the merchant system regarding one or more steps in a product order transaction between the customer and the merchant system;

(c) during the first voice session, receiving over the first data session, by the voice and data processing device from the merchant system, a second merchant record for the merchant comprising a modified session data associated with the one or more steps in the product order transaction, and an effective time duration for establishing a second group of sessions with the merchant system using the second merchant record;

(d) disconnecting the first group of sessions by the voice and data processing device prior to establishing the second group of sessions;

(e) comparing a current time with the effective time duration by the voice processing device;

(f) when the current time is within the effective time duration,

(f1) establishing the second group of sessions, by the voice and data processing device, with the merchant system, the second group of sessions comprising a second voice session and a second data session;

(f2) during the second voice session, sending the modified session data by the voice and data processing device to the merchant system over the second data session; and

(f3) during the second voice session, performing one or more next steps in the product order transaction using the modified session data.

2. The method of claim 1, wherein the receiving (c) comprises:

(c1) during the first voice session, receiving a second session address over the first data session, wherein the second session address is different from the first session address.

3. The method of claim 2, wherein the establishing (f1) comprises:

(f1i) establishing the second group of sessions with the merchant system using the second session address, by the voice and data processing device.

4. The method of claim 1, wherein the first voice session is over Internet.

5. The method of claim 1, wherein the modified session data comprises order information to track a status of the product order.

13

- 6. The method of claim 5, wherein the performing (f3) comprises:
 - (f3i) during the second voice session, receiving the status of the product order by the voice and data processing device.
- 7. The method of claim 1, wherein the second merchant address record expires after the effective time duration.
- 8. The method of claim 1, further comprising:
 - (g) when the current time is not within the effective time duration, establishing the second group of sessions, by the voice and data processing device, with the merchant system using a third merchant address record for the merchant.
- 9. A system for conducting a product order transaction, comprising:
 - a voice and data processing device for:
 - (a) establishing a first group of sessions with a merchant system using a first merchant record for a merchant, the first merchant record comprising a session data and a first session address for the merchant, the first group of sessions comprising a first voice session and a first data session;
 - (b) during the first voice session, processing voice signals between a customer and the merchant system regarding one or more steps in a product order transaction between the customer and the merchant system;
 - (c) during the first voice session, receiving over the first data session, from the merchant system, a second merchant record for the merchant comprising a modified session data associated with the one or more steps in the product order transaction, and an effective time duration for establishing a second group of sessions with the merchant system using the second merchant record;
 - (d) disconnecting the first group of sessions prior to establishing the second group of sessions;
 - (e) comparing a current time with the effective time duration;
 - (f) when the current time is within the effective time duration,

14

- (f1) establishing the second group of sessions with the merchant system, the second group of sessions comprising a second voice session and a second data session;
- (f2) during the second voice session, sending the modified session data to the merchant system over the second data session; and
- (f3) during the second voice session, performing one or more next steps in the product order transaction using the modified session data.
- 10. The system of claim 9, wherein the receiving (c) comprises:
 - (c1) during the first voice session, receiving a second session address over the first data session, wherein the second session address is different from the first session address.
- 11. The system of claim 9, wherein the establishing (f1) comprises:
 - (f1i) establishing the second group of sessions with the merchant system using the second session address, by the voice and data processing device.
- 12. The system of claim 9, wherein the first voice session is over Internet.
- 13. The system of claim 9, wherein the modified session data comprises order information to track a status of the product order.
- 14. The system of claim 13, wherein the performing (f3) comprises:
 - (f3i) during the second voice session, receiving the status of the product order.
- 15. The system of claim 9, wherein the second merchant address record expires after the effective time duration.
- 16. The system of claim 9, wherein the voice and data processing device is further for:
 - (g) when the current time is not within the effective time duration, establishing the second group of sessions with the merchant system using a third merchant address record for the merchant.

* * * * *